

7*918 - Drehriegel, Kunststoff, 4-Fach Halteklip

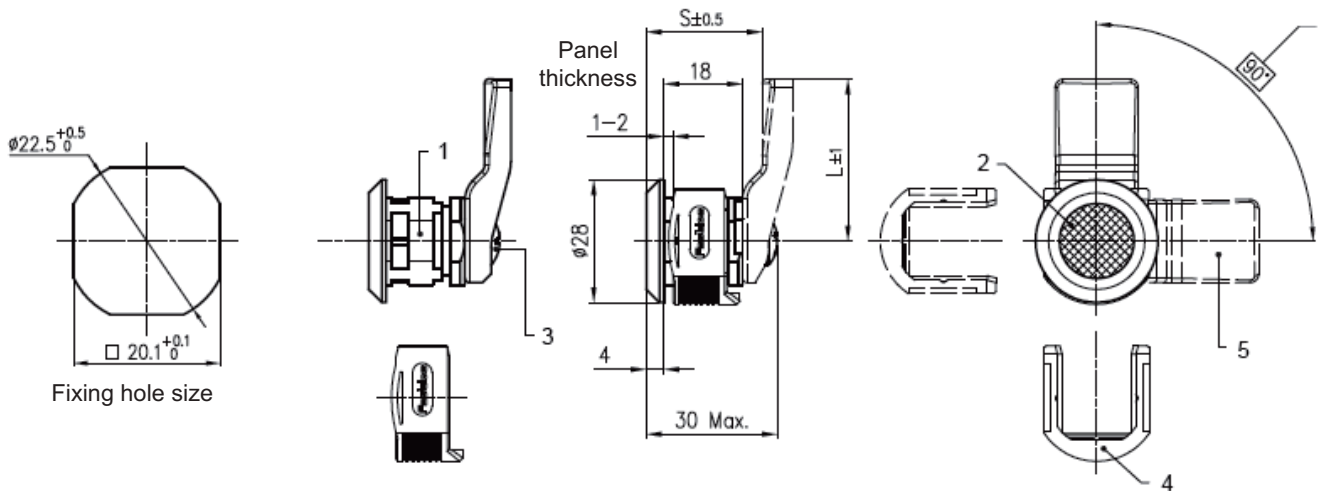

Cam rotation
(see page 40)



Triangle 6,5 mm

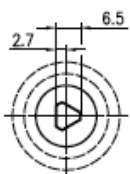

Code: A

Triangle 8 mm

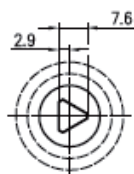

Code: B

Slotted recess

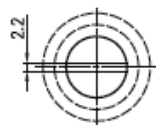

Code: D

Inside hex. 6 mm

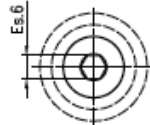

Code: G

Railways square

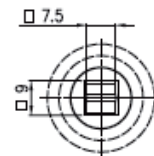

Code: M

P3 pin

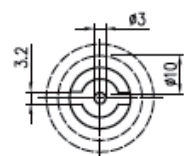

Code: P

Insert * head style "code" into lock part number

Lock Part Number
7*918PNNBW

Ref	Part description	PLASTIC Material - Finishing
1	Housing	PA6.6 + 30%GF Black
2	Cylinder	PA6.6 + 30%GF Black
3	Screw M6X10	Steel - White zinc Cr6 free
4	Clip	PA6.6 + 30%GF Black
5	Cam	PA6.6 + 30%GF Black